

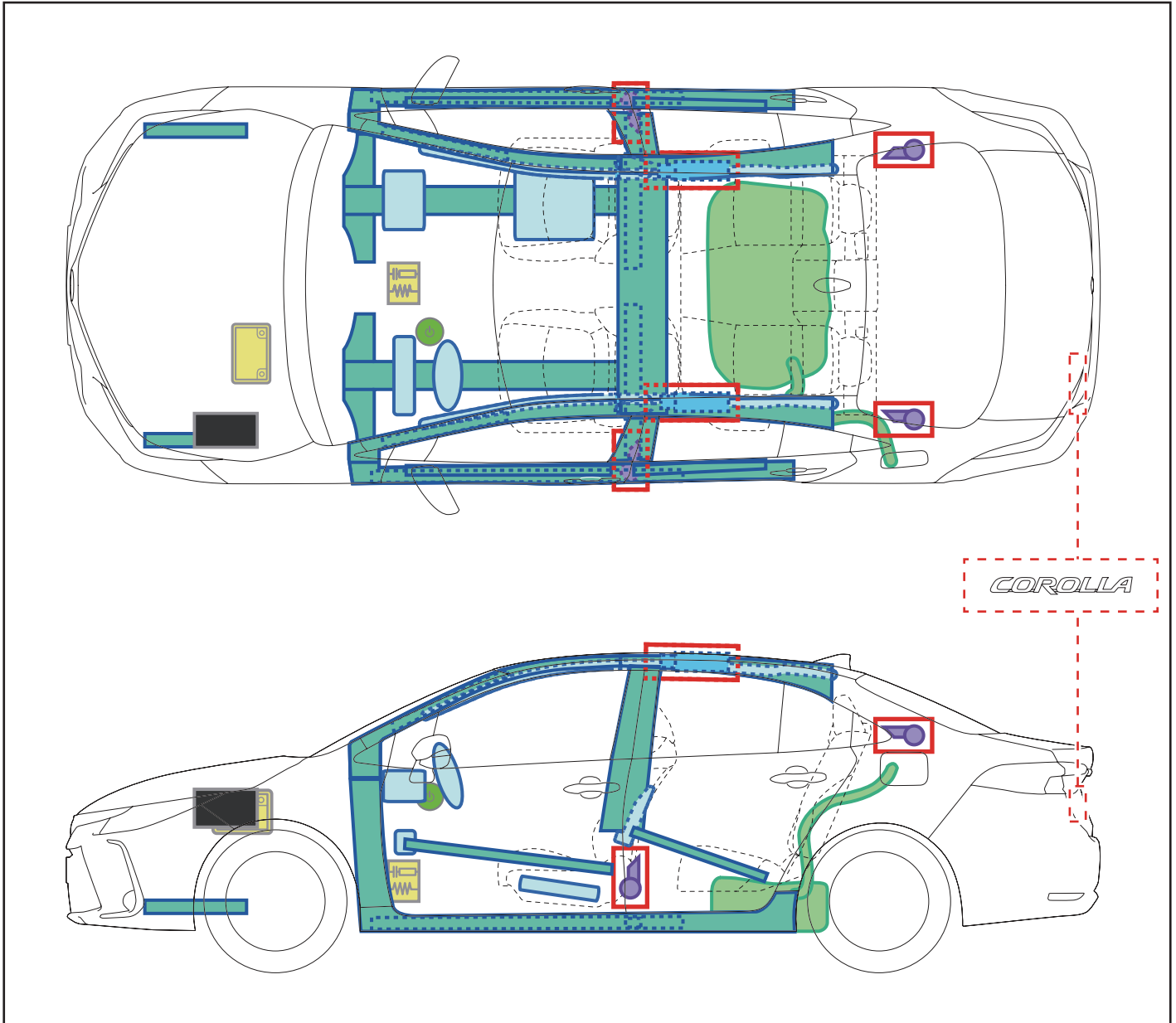

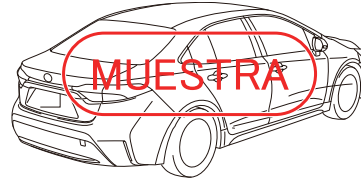

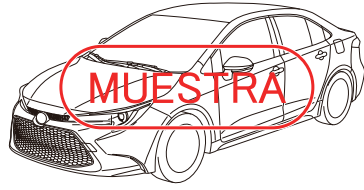

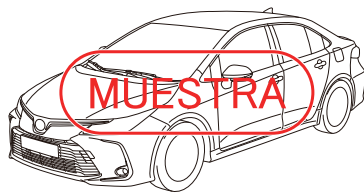



COROLLA

SEDÁN / LHD
(ZRE21#)

2019-1



	INT ALIMENT/ENCEN		Caja de fusibles		Batería de 12V
	Airbag (incl. inflador)		Inflador		Depósito de combustible
	Pretensor del cinturón de seguridad (generador de gas)		Refuerzos estructurales		Ordenador del airbag
-	-	-	-	-	-
-	-	-	-	-	-

Deshabilitación del vehículo

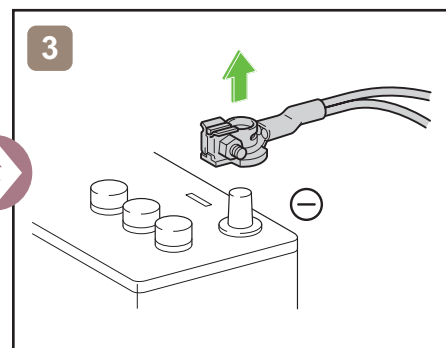
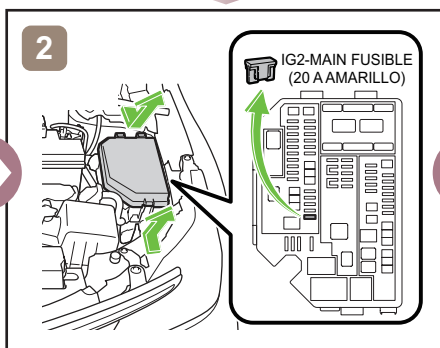
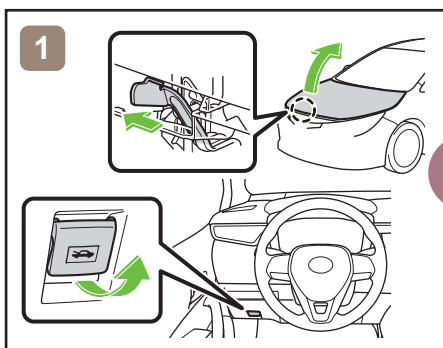
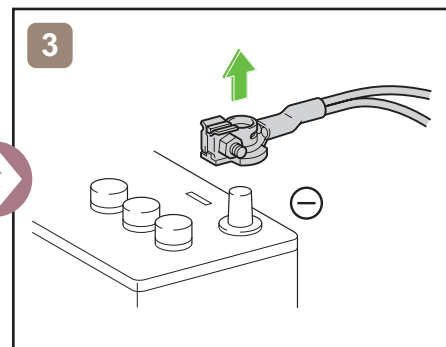
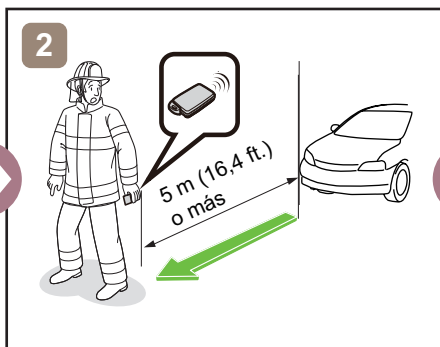
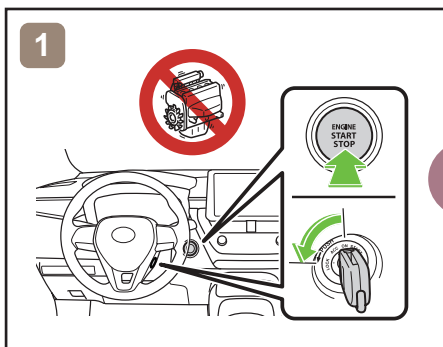

Acceso a la batería de 12V

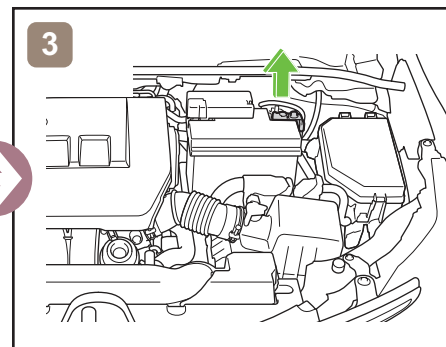
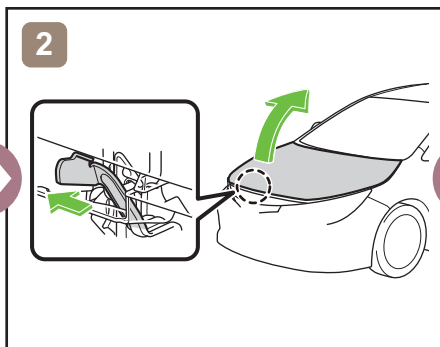
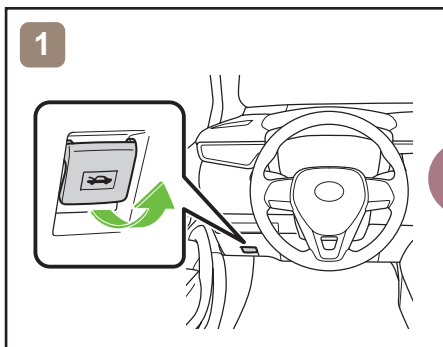

Información sobre el remolque

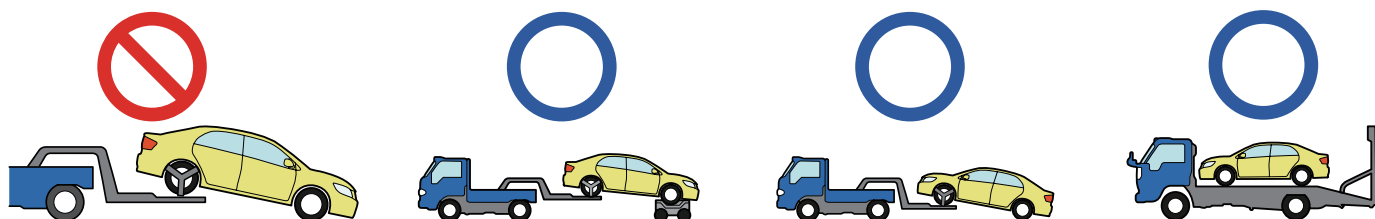

Para más información, consulte la "Guía de Respuesta en Caso Emergencia".

<http://www.toyota.co.jp/#####/>